



CERTIFICATE OF APPROVAL

No CF 5784

This is to certify that, in accordance with
TS00 General Requirements for Certification of Fire Protection Products
The undermentioned products of

Oxted Window Systems Ltd and OWS Fire Rated Ltd

34a Hobbs Industrial Estate, Eastbourne Road, Lingfield,
RH7 6HN

Tel: 01342 836630

Have been assessed against the requirements of the Technical Schedule(s)
denoted below and are approved for use subject to the conditions
appended hereto:

CERTIFIED PRODUCT

Aluminium Framing Systems
Type MB 78 EI for Glazed
Walls and Doors

TECHNICAL SCHEDULE

TS25 Fire Resistant Glass,
Glazing Systems and
Materials

Signed and sealed for and on behalf of Warringtonfire Testing and Certification Limited

Issued: 7th November 2019
Valid to: 27th May 2024

Paul Duggan
Certification Manager

Page 1 of 29





CERTIFICATE No CF 5784

Oxted Window Systems Ltd and OWS Fire Rated Ltd

Aluminium Framing Systems Type MB[®] 78 EI for glazed non loadbearing internal and external fire walls, internal and external single leaf and double leaf fire doors and single leaf and double leaf sliding automatic doors

This Certificate of Approval relates to the contribution to fire resistance of the aluminium framing systems type MB-78 EI when used in the above applications as defined in BS 476: Part 22: 1987, EN 1364-1, and EN 1634-1: subject to the undermentioned conditions.

Application	Fire Resistance Performance Integrity and Insulation (minutes)	Page No.
Configurations for Aluminium Framing Systems Type MB [®] 78 EI	N/A	7-8
Aluminium Framing Systems Type MB [®] 78 EI showing cross sections of doors and screens	30	9
Aluminium Framing Systems Type MB [®] 78 EI showing cross sections of doors and screens	60	10
Aluminium Framing Systems Type MB [®] 78 EI showing doors and screens	90	11
Aluminium Framing Systems Type MB [®] 78 EI for Single and Double Leaf Sliding Automatic Doors	30	12-13
Non Transparent Panels for Glazing into MB 78EI Aluminium Doors and Walls	30, 60 & 90	14
System Parts for Aluminium Framing Systems Type MB [®] 78 EI	N/A	15
Insulation Parts for Aluminium Framing Systems Type MB [®] 78 EI	N/A	16-21
Gaskets and Accessories for Aluminium Framing Systems Type MB [®] 78 EI	N/A	22-23
Sealants, Glues and Cleaning Agents for Aluminium Framing Systems Type MB [®] 78 EI	N/A	24
Hardware List for Aluminium Doorsets Type MB [®] 78 EI	N/A	25-28
List of Approved System Suppliers	N/A	29



CERTIFICATE No CF 5784

Oxted Window Systems Ltd and OWS Fire Rated Ltd

Aluminium Framing Systems Type MB[®] 78 EI for glazed non loadbearing internal and external fire walls, internal and external single leaf and double leaf fire doors and single leaf and double leaf sliding automatic doors

These products are approved on the basis of:

- a) Initial type testing
- b) A design appraisal against Technical Schedule TS25
- b) Inspection and surveillance of factory production control
- c) Product surveillance under BS EN ISO 9001: 2008
- d) Audit Testing in accordance with Technical Schedule TS25

Note 1: This Certificate of Approval must be read in conjunction with CERTIFIRE Technical Schedule TS25, Fire Resistant Glass, Glazing Systems and materials.

Note 2: The MB-78 EI system for internal or external doors can be installed in internal or external MB-78 EI system walls of at least the same fire resistance. The doors can be externally hinged, single and double leafed, and be glazed with fire resistant glass or opaque infill panels.

Note 3: MB-78 EI systems can be used within or form the entire fire resistant internal or external walls. They are made up from a kit of products covering aluminium profiles with and without thermal barriers, aluminium glazing beads, connectors, gaskets, expanding and fire protection inserts, stainless aluminium elements, sealing element, materials and glues, silicate cement boards and spacers, plasterboards, pane pads, glass panes and opaque infill panels to provide the necessary fire resistance. In all cases the screens can be installed either upright or at an angle of $\pm 10^{\circ}$ from the vertical without compromising the fire resistance performance.

Note 4: The technical properties of the door leaves and screens such as values of opening forces, resistance to open and closing cycles, static loading, static torsion, wind loading, shock, soft and hard body impact, thermal resistance the wide ranging possibilities for interchangeability and connections of the various parts of the doors and screens can be confirmed directly with the certificate holder.

This approval relates to on-going production. Product and/or its immediate packaging is identified with the manufacturer's name, the product name or number, the CERTIFIRE name or name and mark, together with the CERTIFIRE certificate number and application when appropriate.

This certification is provided to the client for their own purposes and we cannot opine on whether it will be accepted by Building Control authorities or any other third parties for any purpose.



CERTIFICATE No CF 5784

Oxted Window Systems Ltd and OWS Fire Rated Ltd

Aluminium Framing Systems Type MB[®] 78 EI for glazed non loadbearing internal and external fire walls, internal and external single leaf and double leaf fire doors and single leaf and double leaf sliding automatic doors

Other Information

The design appraisal for aluminium framing systems type MB-78 EI has been made on the basis of Technical Schedule TS25 and therefore this Certificate of Approval relates to the contribution to fire resistance for aluminium framing systems type MB-78 EI when used in applications as defined in BS 476: Part 22:1987.

However, aluminium framing systems type MB-78 EI have been extensively tested against EN 1364-1, and EN 1634-1 when used for:

- Internal and external fire walls and doors as defined in EN 1364-1 and for internal and external fire doors as defined in EN 1634-1. These products have been classified according to EN 13501-2+A1:2009 for fire resistance periods of E30, E60, EI15, EI30, EI45, EI60 and EI90 (dependent on system).
- Single leaf and double leaf sliding automatic doors as defined in EN 1634-1. These products have been classified according to EN 13501-2+A1:2009 for fire resistance periods of E30-C5, EI₁20-C5, EI₂30-C5 and EW30-C5 (dependent on system).

Note: the fire resistance of doors with insulation performance is classified 'I₂' according to EN 13501-2+A1:2009. In the case of doors with a threshold and with a rebate gasket or without a threshold but with an automatic threshold seal, they may also meet smoke control classes Sa and Sm according to EN 13501-2+A1:2009.



CERTIFICATE No CF 5784

Oxted Window Systems Ltd and OWS Fire Rated Ltd

Aluminium Framing Systems Type MB[®] 78 EI for glazed non loadbearing internal and external fire walls, internal and external single leaf and double leaf fire doors and single leaf and double leaf sliding automatic doors

Product Description

The MB-78 EI aluminium glazing system for fire-resistant walls can be used for the construction of internal or external fire walls including single leaf and double leaf doors and for single and double leaf sliding automatic doors for fire resistance performance of up to 90 minutes according to BS 476 Part 22:1987, EN 1364-1, and EN 1634-1: The system has also been determined as non-fire propagating and may be used for the purpose of building smoke-proof constructions.

The application of glazed fire resistant barriers in the building industry is subject to the fire resistant requirements of the building, applicable standards and relevant regulations. The framing system designs that can be offered are covered in this Certificate. Supporting test evidence is available from the certificate holder on request.

The construction of the MP-78 EI system is based on 78 mm deep aluminium profiles with thermal spacers. The system features a low heat transfer coefficient value (Uf) due to the application of special (moulded) 34 mm wide thermal spacers and gaskets.

Depending on the required fire resistance performance, fire resistant insulation materials – GKF or CI are inserted in the inside chambers of profiles and in the insulation space between the profiles. Work required in connecting of the profiles is reduced to a minimum due to the use of aluminium connecting members and auxiliary accessories provided with the system. Corner connections of “L” type are formed by trimming the ends of the frame or leaf profiles at an angle of 45°, followed by crimping or pinning and gluing (with two-part CORALGLUE®) to aluminium corner cleats embedded in the inner chambers of profiles. The “T” type joints are formed by pinning of crosspieces to embedded corner cleats and gluing with CORALGLUE®.

Window panes or other infill types are mounted in steel holders with glued on ceramic gaskets and masked with glazing beads and EPDM gaskets. Such technique for infill installation enables easy replacement of damaged glass panes and secures good tightness to water infiltration. The system allows for the use of fire resistant glass products as shown in the attached tables (glazing thickness from 6mm up to 49 mm. Shims are made of a fire resistant material.

Each construction of the MB-78 EI system is designed to be fitted in external developments and must be equipped with an efficient drainage and ventilation system deflecting water from the pane chamber.

Additionally, acoustic tests have been performed on the MP-78 EI system and demonstrate that constructions based on this system feature very good sound-insulation performance.



CERTIFICATE No CF 5784
Oxted Window Systems Ltd and OWS Fire Rated Ltd

Aluminium Framing Systems Type MB[®] 78 EI for glazed non loadbearing internal and external fire walls, internal and external single leaf and double leaf fire doors and single leaf and double leaf sliding automatic doors

Fire Resisting Glass Panes

This aluminium framing system Type MB[®] 78 EI is CERTIFIRE approved for the inclusion of glazed apertures.

Any CERTIFIRE approved fire resisting glass may be glazed subject to the limitations contained in the appropriate glass Certificate.

Fire resisting glass panes which are not covered by CERTIFIRE Certificates may be glazed into aluminium framing system Type MB[®] 78 EI as described in official fire test reports held on file by the certificate holder.

CERTIFICATE No CF 5784 Oxted Window Systems Ltd and OWS Fire Rated Ltd

Configurations for Approved Aluminium Framing Systems Type MB[®] 78 EI

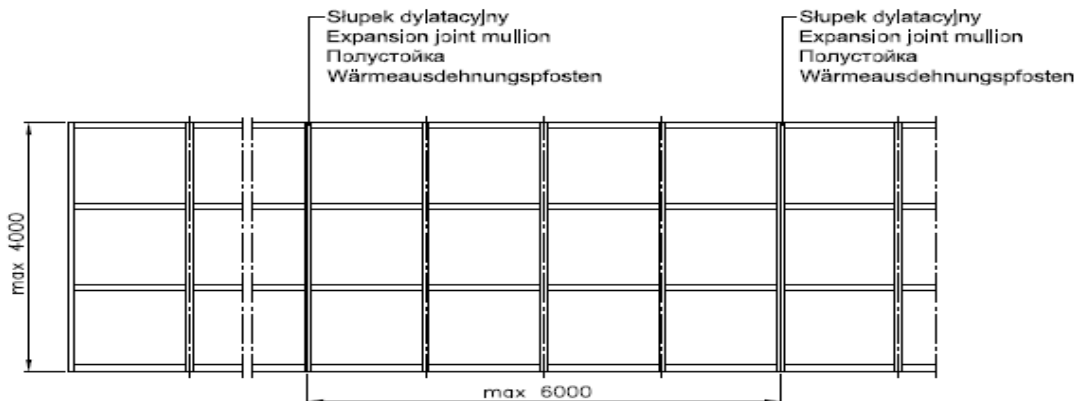
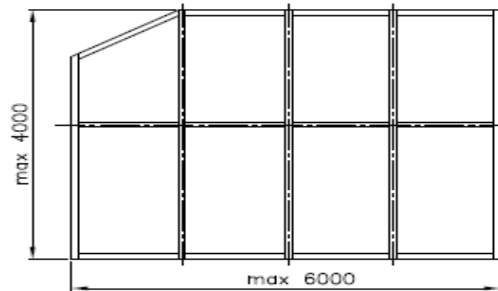
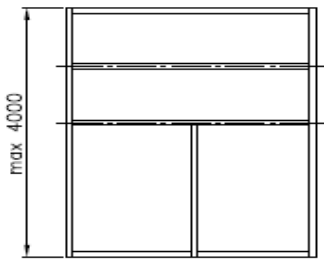

Okno techniczne Technical window Техническое окно Technische Fenster

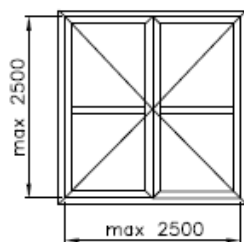
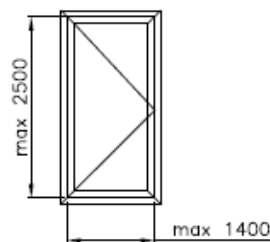
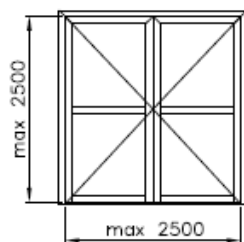
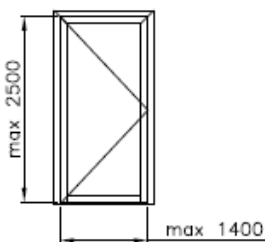

CERTIFICATE No CF 5784 Oxted Window Systems Ltd and OWS Fire Rated Ltd

Configurations for Approved Aluminium Framing Systems Type MB[®] 78 EI
(continued)

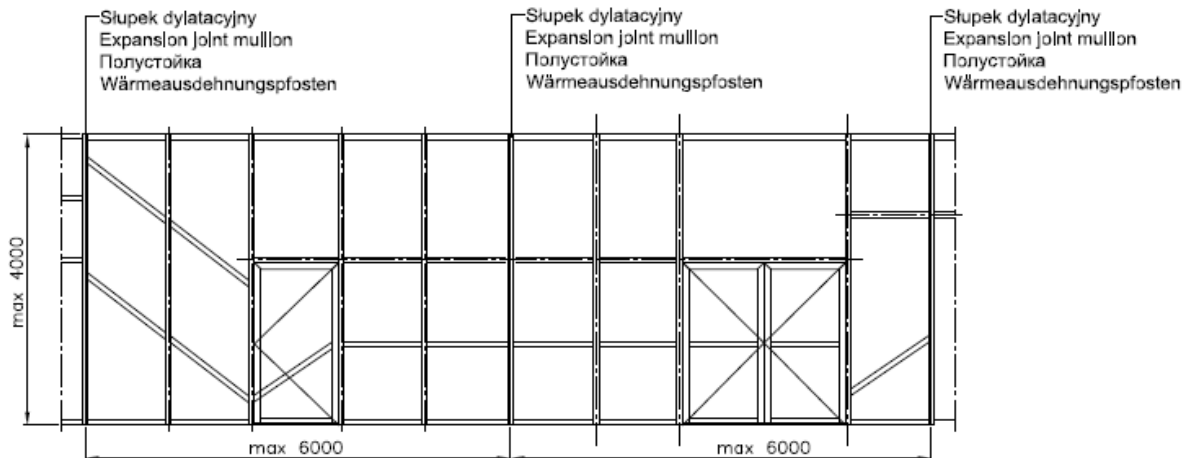
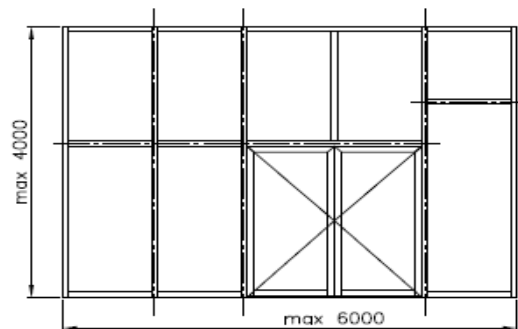
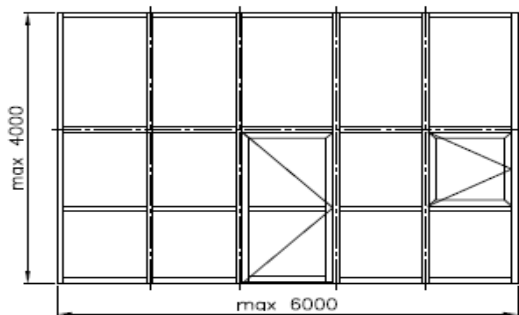
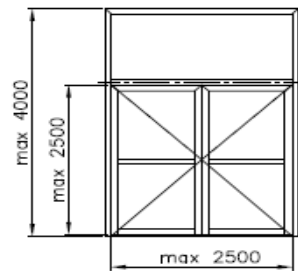
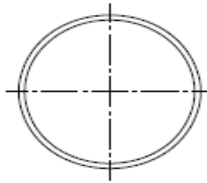
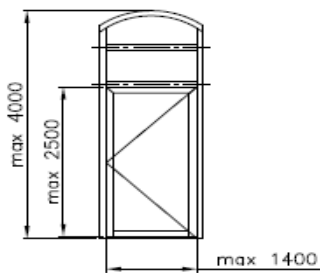

CERTIFICATE No CF 5784

Oxted Window Systems Ltd and OWS Fire Rated Ltd

Sections of Approved Aluminium Framing Systems Type MB[®] 78 EI - examples

Doors 30 minute Integrity and Insulation

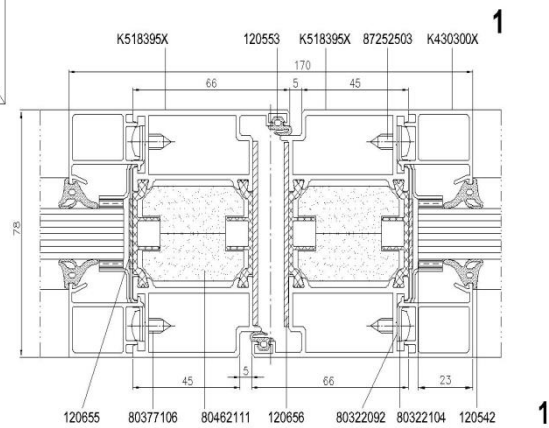
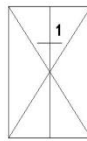
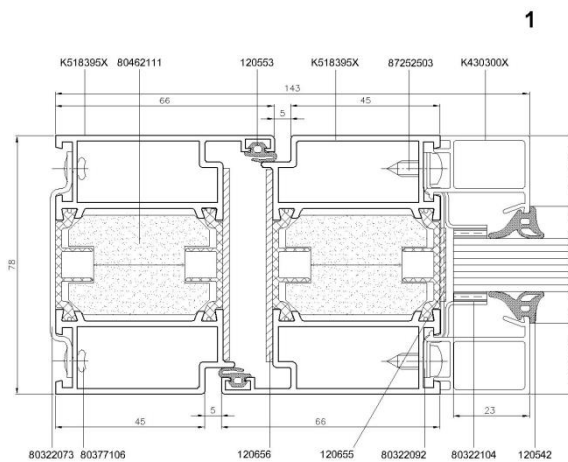
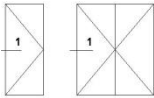

Screens 30 minute Integrity and Insulation

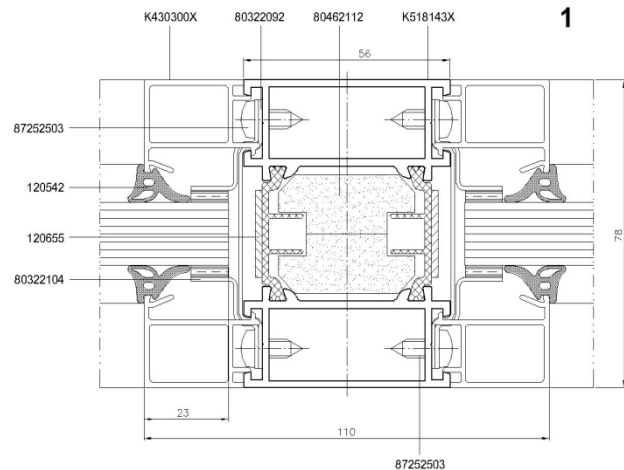
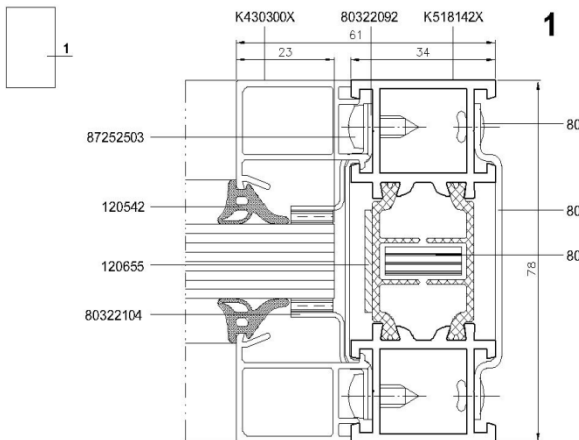
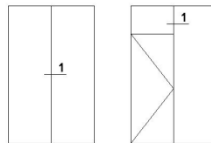

Sections of Approved Aluminium

CERTIFICATE No CF 5784 Oxted Window Systems Ltd and OWS Fire Rated Ltd

Framing Systems Type MB[®] 78 EI - examples

Doors 60 minute Integrity and Insulation

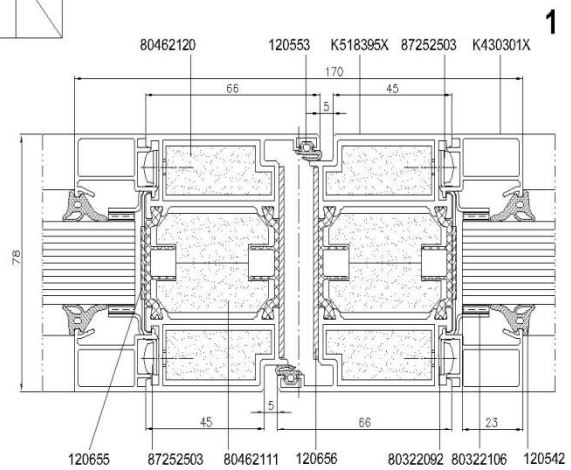
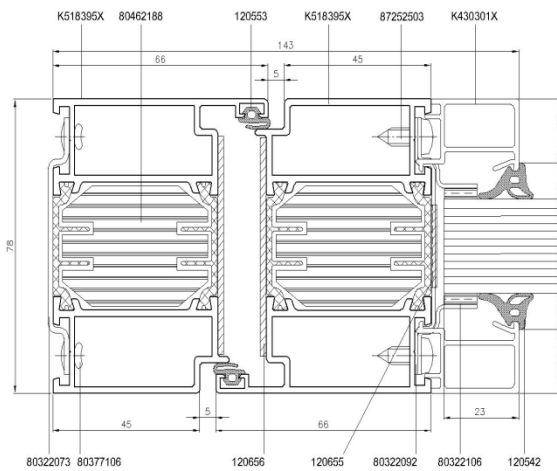
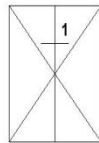
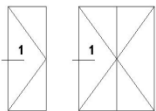

Screens 60 minute Integrity and Insulation

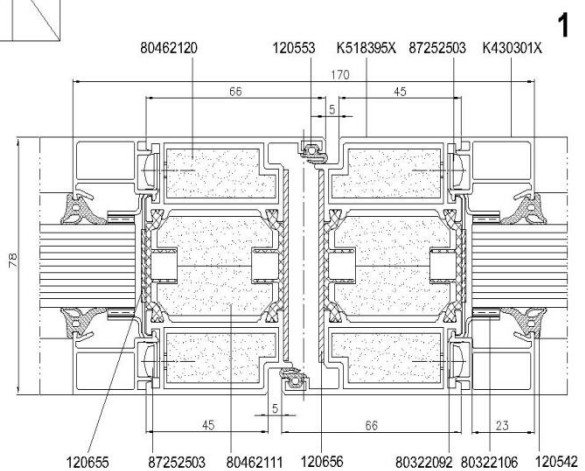
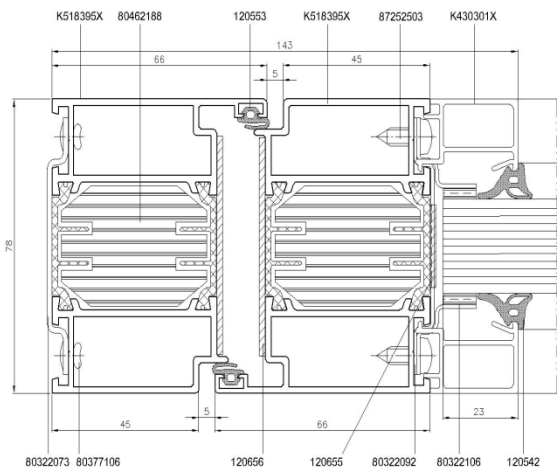
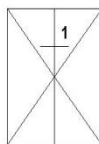
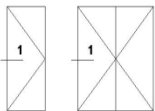

Kal Duggan

CERTIFICATE No CF 5784

Oxted Window Systems Ltd and OWS Fire Rated Ltd

Sections of Approved Aluminium Framing Systems Type MB[®] 78 EI - examples

Doors: 90 minute Integrity and Insulation

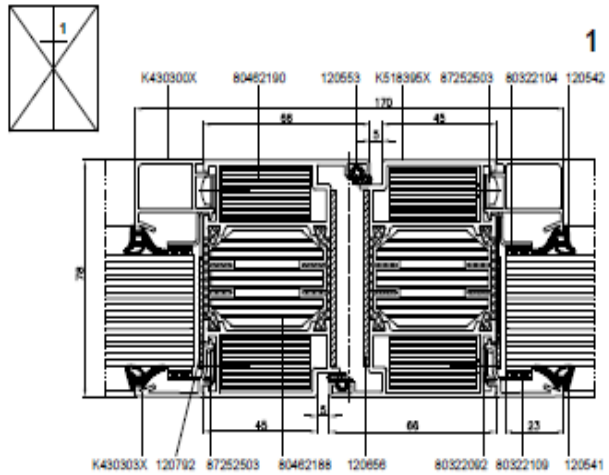
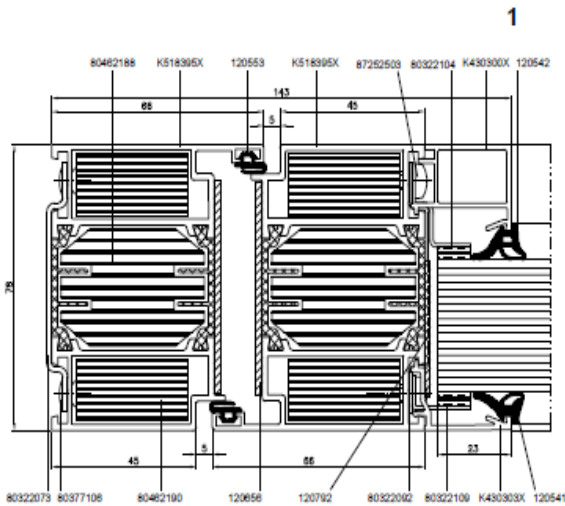
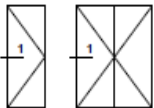

Screens 90: minute Integrity and Insulation

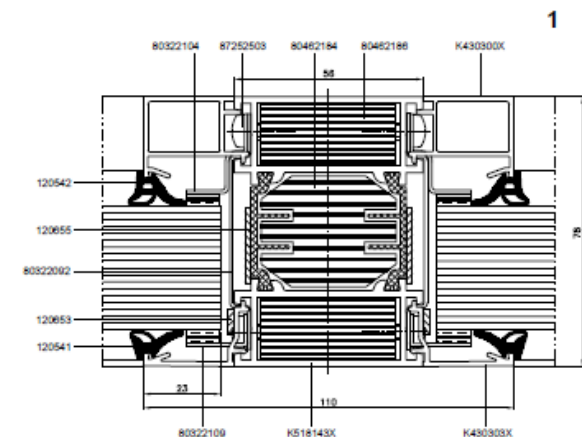
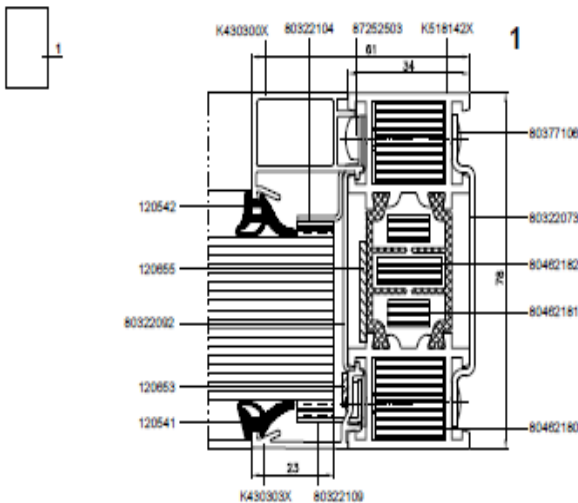
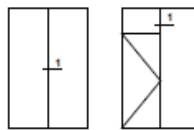

Sections of Approved Aluminium

CERTIFICATE No CF 5784

Oxted Window Systems Ltd and OWS Fire Rated Ltd

Sections of Approved Aluminium Framing Systems Type MB[®] 78 EI – Single and Double Leaf Sliding Automatic Door examples (continued)

Sliding doors: 30 minute Integrity and Insulation

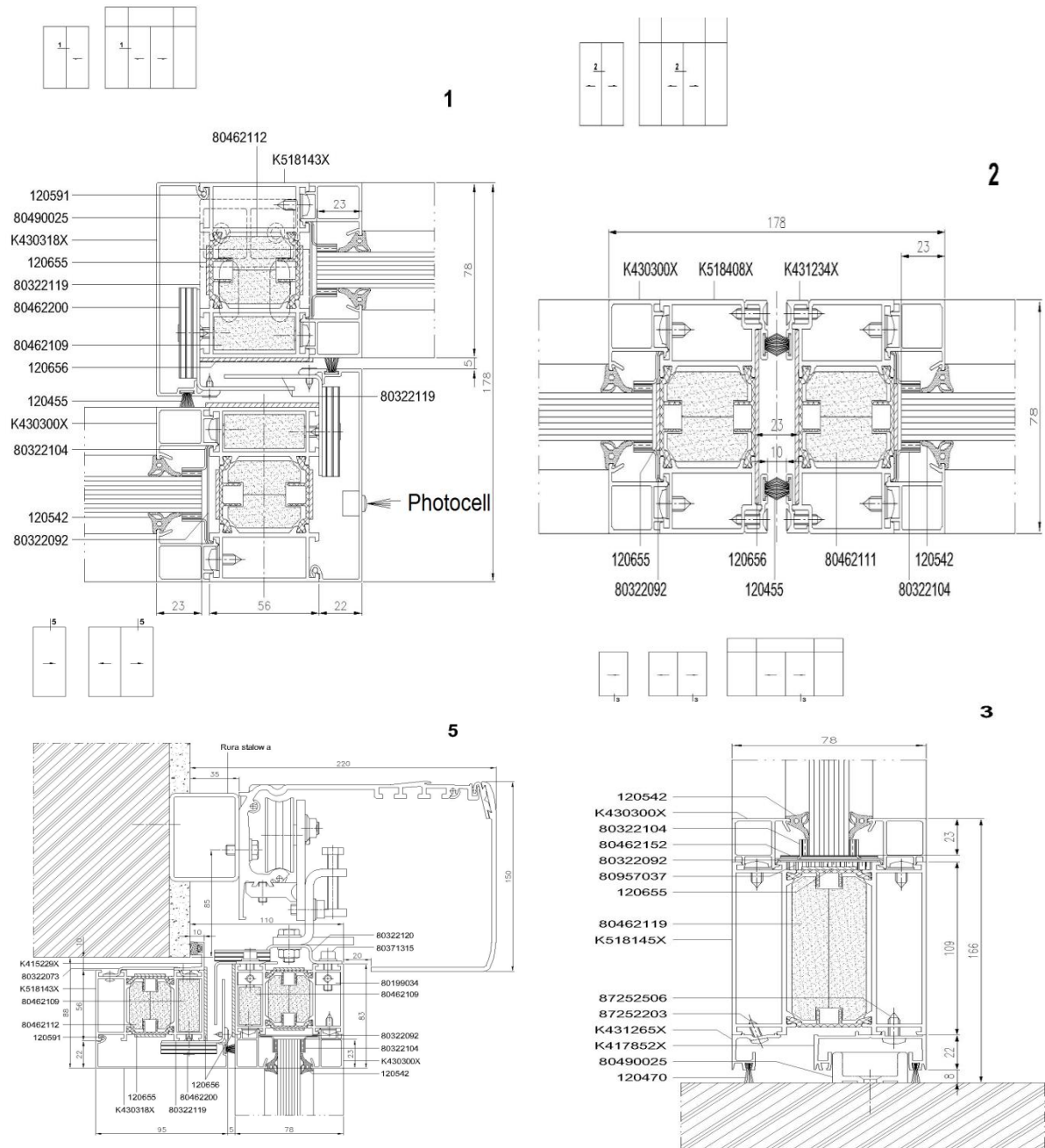

CERTIFICATE No CF 5784

Oxted Window Systems Ltd and OWS Fire Rated Ltd

Description of Non Transparent Panels for Glazing into MB 78EI Aluminium Doors and Walls

Panels of non-transparent sections are built as sandwiched elements arranged as follows:

Doors and walls for 30 minute Integrity and Insulation:

- A sandwich element, made of a GKF plasterboard of thickness 15 mm, or two boards 12.5 mm thick, covered on both sides with aluminium sheet (anodized or paint coated) of thickness 1.5 ÷ 3 mm or steel (stainless or paint coated) of thickness 0.8 ÷ 1.25 mm.
- A sandwich element, made of two Promatect H boards 12 mm thick each, covered on both sides with aluminium sheet (anodized or paint coated) of thickness 1.5 ÷ 3 mm or steel sheet (stainless or paint coated) of thickness 0.8 ÷ 1.25 mm or a pane of tempered glass min. 6 mm thick.

Doors and walls for 60 minute Integrity and Insulation:

- A sandwich element, made of two GKF plasterboards of thickness 15 mm each, or three boards 12.5 mm thick, covered on both sides with aluminium sheet (anodized or paint coated) of thickness 1.5 ÷ 3 mm or steel sheet (stainless or paint coated) of thickness 0.8 ÷ 1.25 mm.
- A sandwich element, made of three Promatect H boards 12 mm thick each or two Promatect H boards 15 mm thick, covered on both sides with aluminium sheet (anodized or paint coated) of thickness 1.5 ÷ 3 mm or steel sheet (stainless or paint coated) of thickness 0.8 ÷ 1.25 mm or a pane of tempered glass min. 6 mm thick.

Doors and walls for 90 minute Integrity and Insulation:

- A sandwich element, made of two GKF plasterboards of thickness 15 mm each and one board 12.5 mm thick, covered on both sides with steel sheet (stainless or paint coated) of thickness 0.8 ÷ 1.25 mm.
- A sandwich element, made of two Promatect H boards 15 mm thick each and one board 12 mm thick, covered on both sides with steel sheet (stainless or paint coated) of thickness 0.8 ÷ 1.25 mm.

To increase thermal insulation performance of panels of non-transparent sections applied in external developments, a layer of mineral wool of the density 70 kg/m³ may be additionally applied inside.

CERTIFICATE No CF 5784

Oxted Window Systems Ltd and OWS Fire Rated Ltd

System Parts for Approved Aluminium Framing Systems Type MB[®] 78 EI

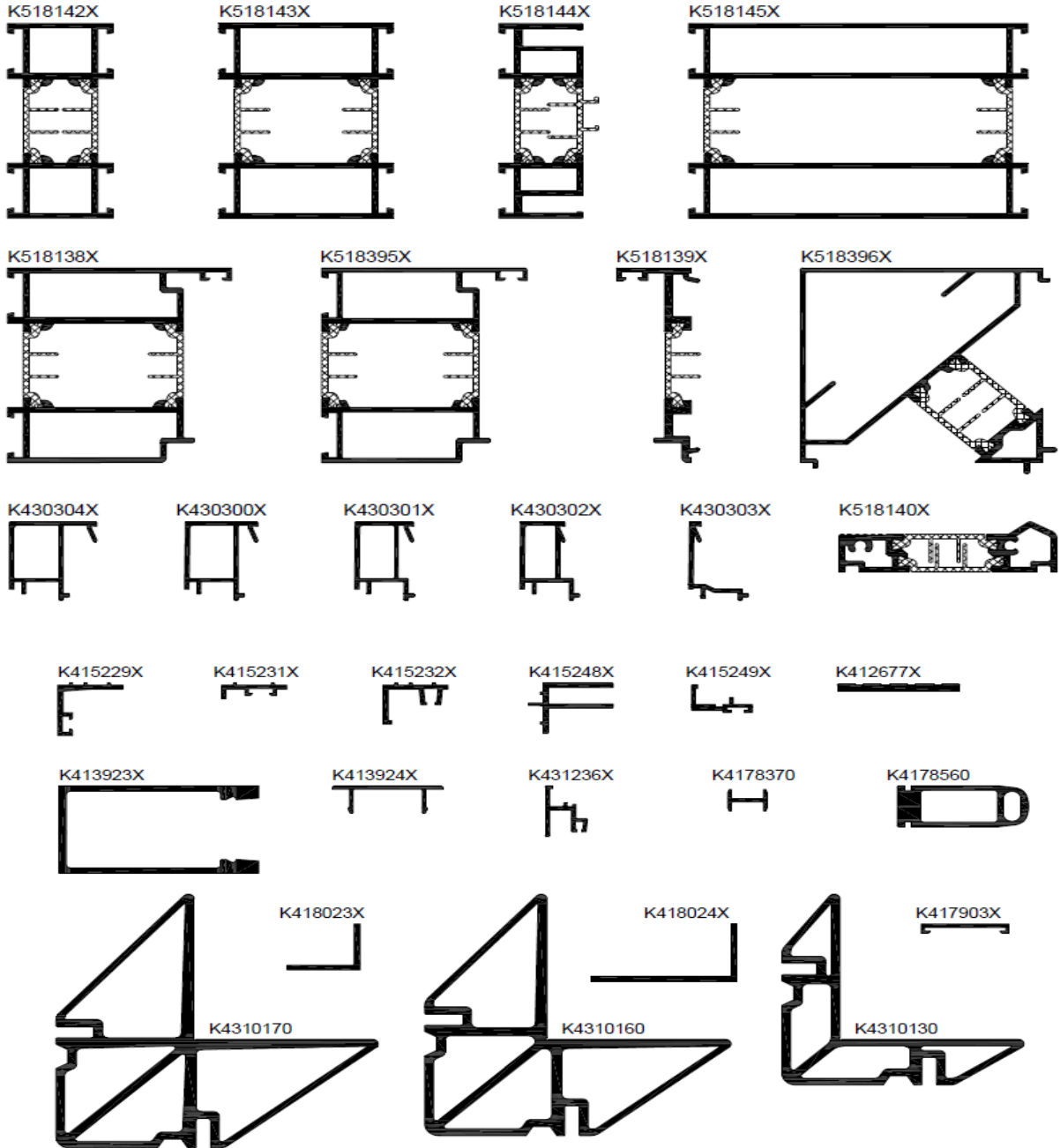

Paul Duggan

CERTIFICATE No CF 5784 Oxted Window Systems Ltd and OWS Fire Rated Ltd

Insulation Parts for Approved Aluminium Framing Systems Type MB[®] 78 EI

80462109

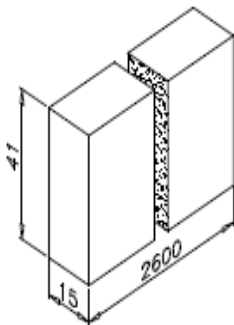

80462110

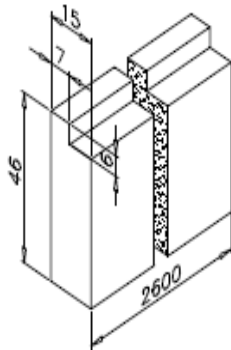

80462111

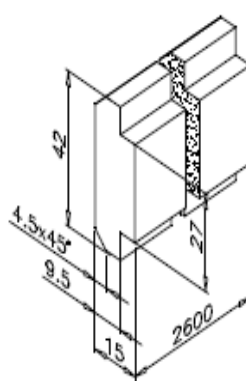

80462112

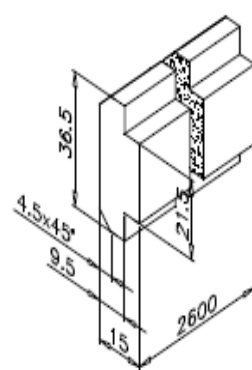

80462113

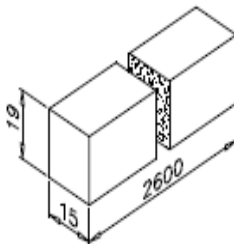

80462118

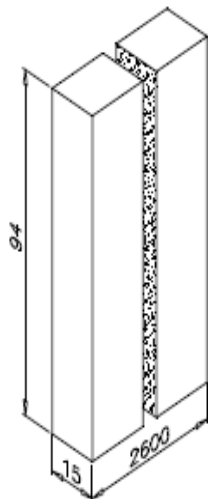

80462119

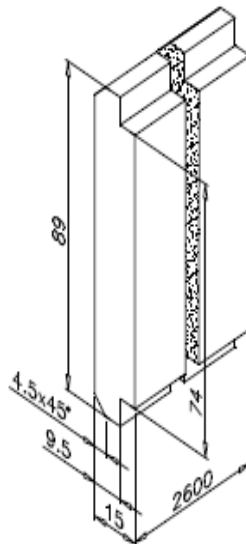

80462120

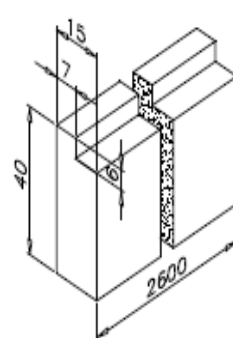

CERTIFICATE No CF 5784

Oxted Window Systems Ltd and OWS Fire Rated Ltd

Insulation Parts for Approved Aluminium Framing Systems Type MB[®] 78 EI
(continued)

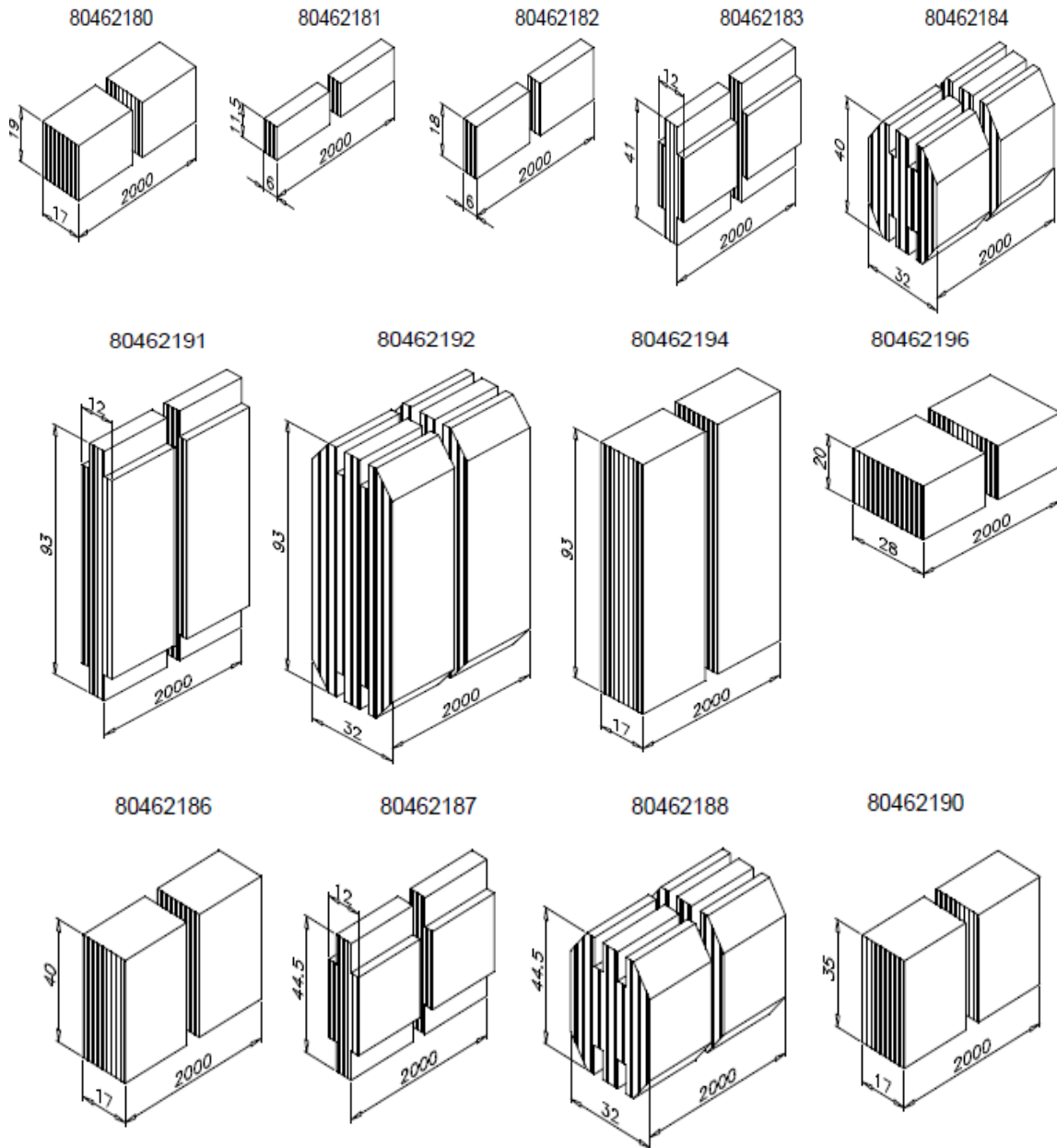

Paul Dwyer

CERTIFICATE No CF 5784 Oxted Window Systems Ltd and OWS Fire Rated Ltd

Insulation Parts for Approved Aluminium Framing Systems Type MB[®] 78 EI
(continued)

80322073

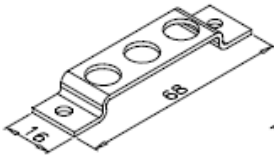

80322074

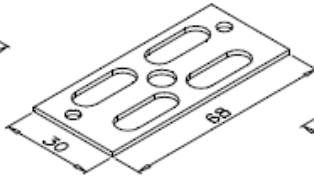

80322075

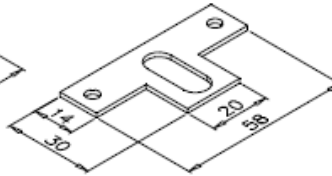

80322076

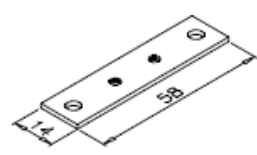

80322077

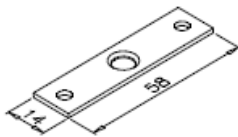

80322080

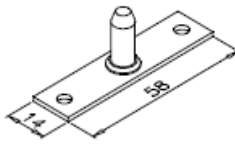

80322081

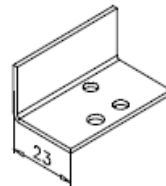

80322082

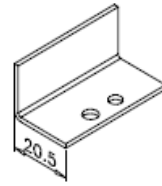

80322083

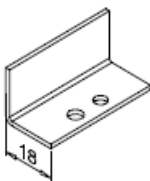

80322084

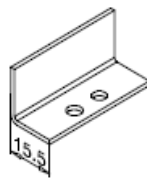

80322085

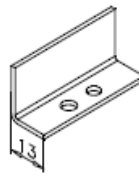

80322087

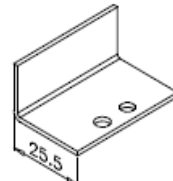

80322116

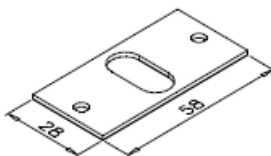

80322117

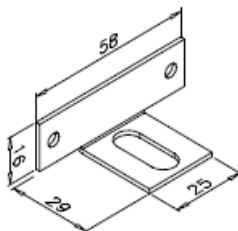

80328041

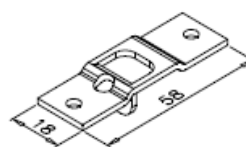

CERTIFICATE No CF 5784 Oxted Window Systems Ltd and OWS Fire Rated Ltd

Insulation Parts for Approved Aluminium Framing Systems Type MB[®] 78 EI
(continued)

80322086

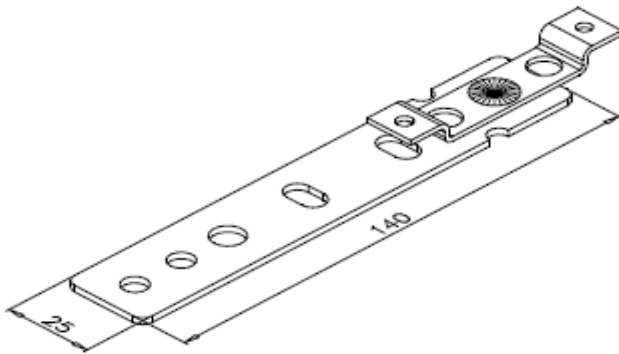

80322092

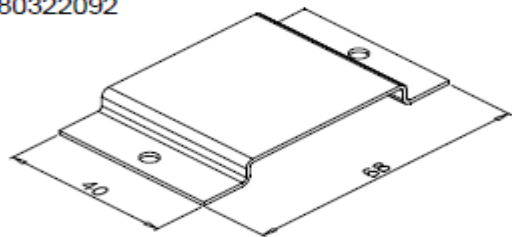

80322103

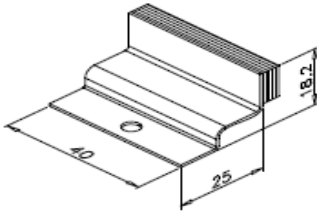

80322104

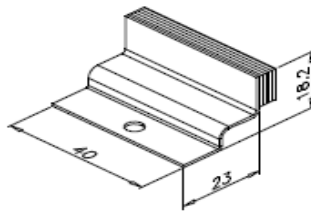

80322105

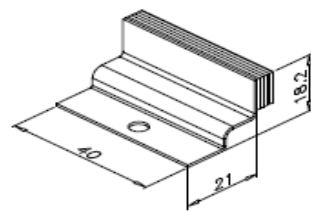

80322106

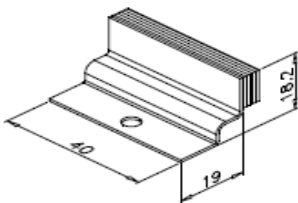

80322107

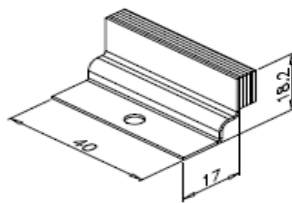

80322108

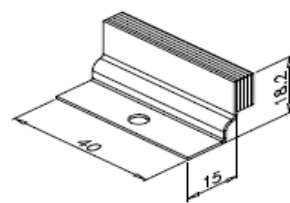

80322109

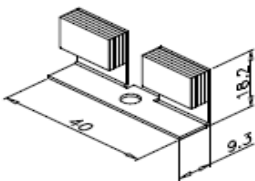

CERTIFICATE No CF 5784 Oxted Window Systems Ltd and OWS Fire Rated Ltd

Insulation Parts for Approved Aluminium Framing Systems Type MB[®] 78 EI
(continued)

80124321

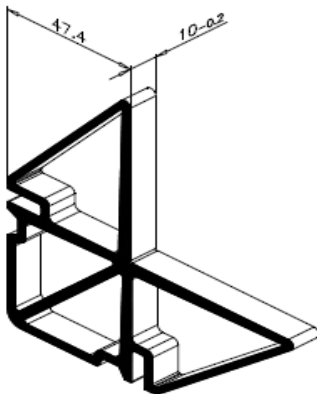

80124271

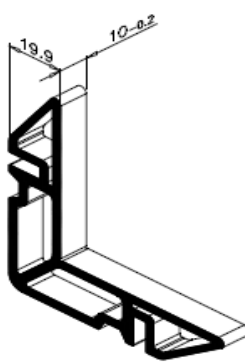

80124270

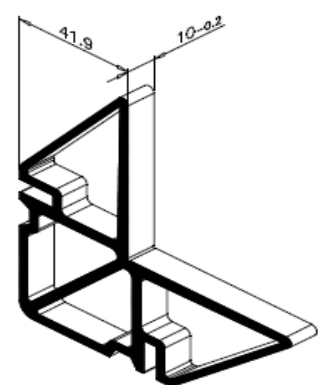

80122106

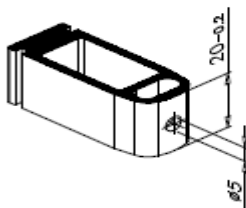

80122109

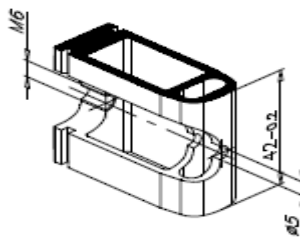

80122111

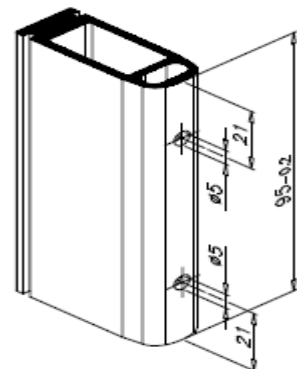

80111320

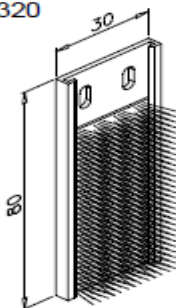

80111350

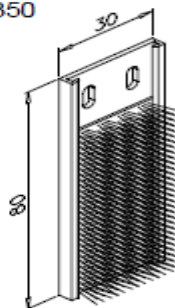

004327

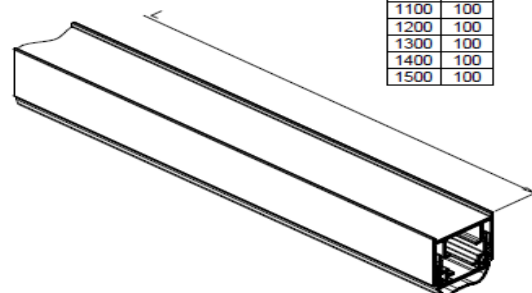

L	X
350	170
400	50
500	100
600	100
700	100
800	100
900	100
1000	100
1100	100
1200	100
1300	100
1400	100
1500	100

Paul Duggan

CERTIFICATE No CF 5784 Oxted Window Systems Ltd and OWS Fire Rated Ltd

Insulation Parts for Approved Aluminium Framing Systems Type MB[®] 78 EI
(continued)

87122203

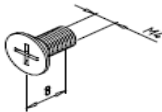

87122305

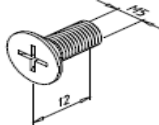

87222202



87222203



87222206

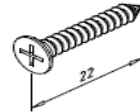

87222504



87222506

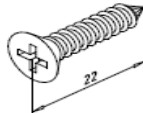

87252203



87252204

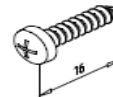

87252503

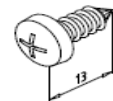

87252506

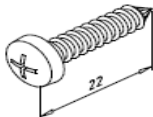

80372710

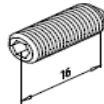

80376014

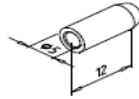

80376015

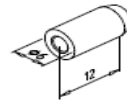

80377243



80371207

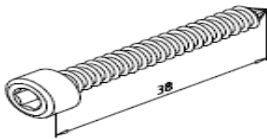

80377106

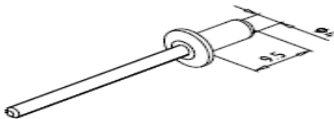

87222513

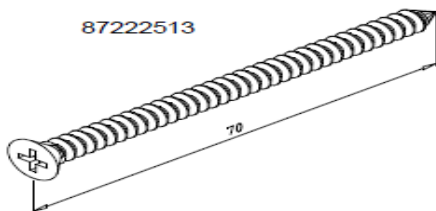

Paul Duggan

CERTIFICATE No CF 5784

Oxted Window Systems Ltd and OWS Fire Rated Ltd

Gaskets and Accessories for Approved Aluminium Framing Systems Type MB® 78 EI

120460



120510



120553



120563

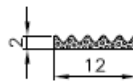

120757



120774

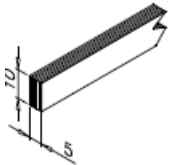

120775

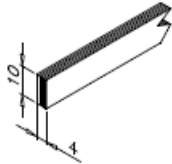

120776

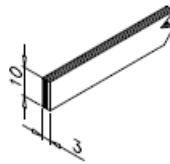

120653

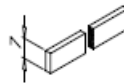

120655

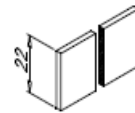

120792

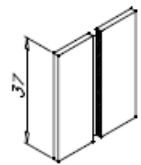

120564

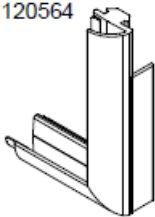

120565

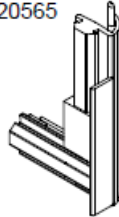

120444



120470



120529

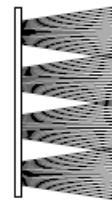

120656

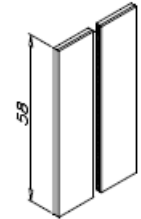

120449

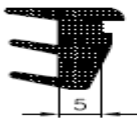

120451

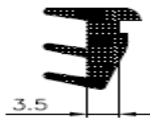

120452

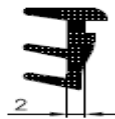

120753



120540



120541



120542



120604



80462081

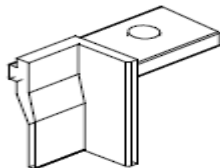

80462082

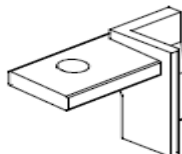

Paul Duggan

CERTIFICATE No CF 5784

Oxted Window Systems Ltd and OWS Fire Rated Ltd

Gaskets and Accessories for Approved Aluminium Framing Systems Type MB[®] 78 EI (continued)

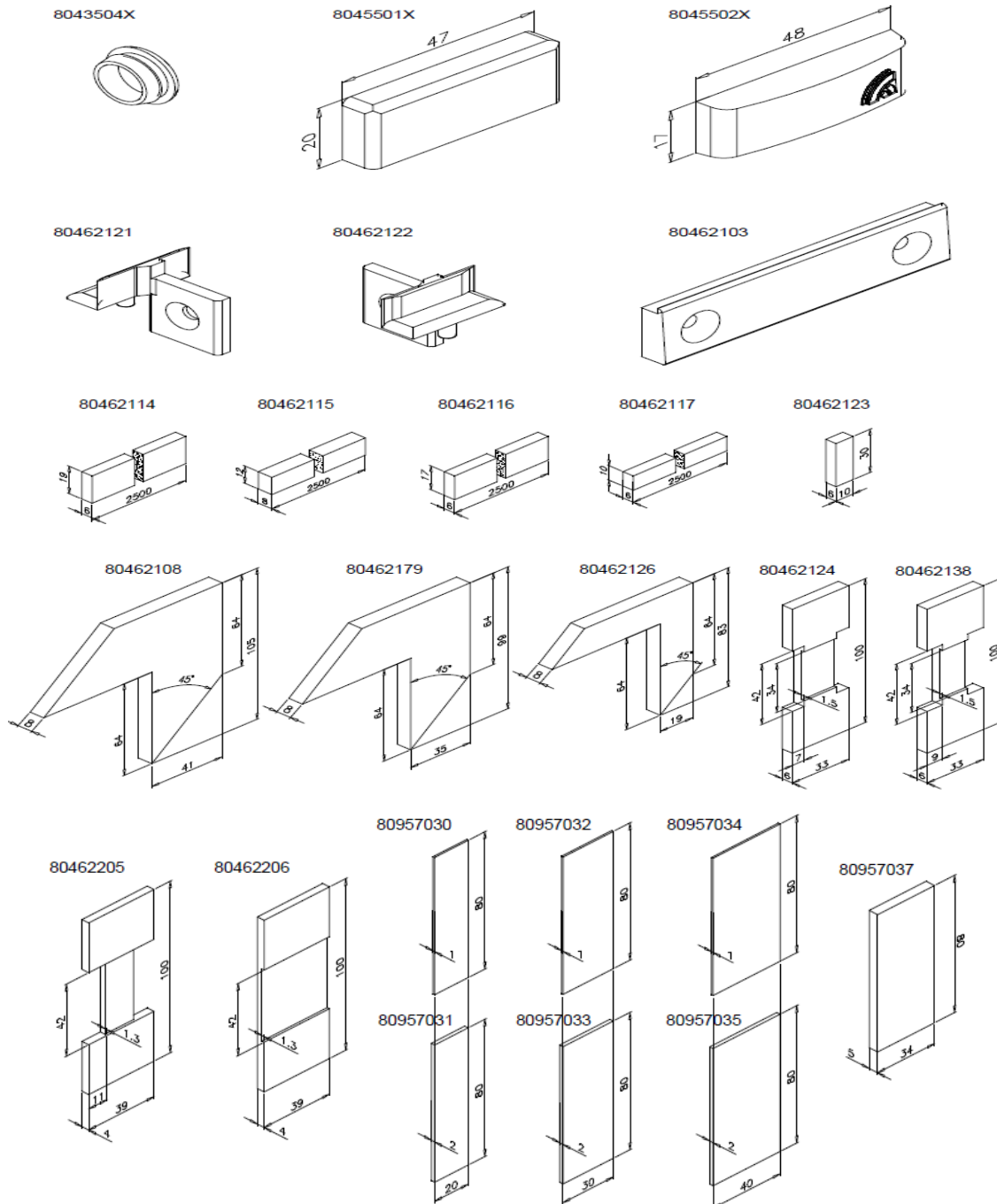

Paul Duggan

CERTIFICATE No CF 5784

Oxted Window Systems Ltd and OWS Fire Rated Ltd

Sealants, Glues and Cleaning Agents for Approved Aluminium Framing Systems Type MB[®] 78 EI

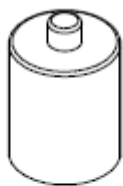

12894900

Cleaning agent Coralclean

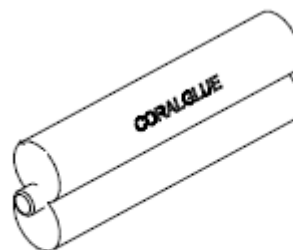

13364612

Two-component glue CORALGLUE

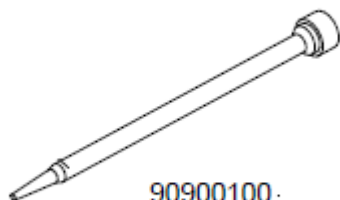

90900100

Mixing nosel



13364617

One-component adhesive utilized to glue gaskets and details. Surfaces may be cleaned with Coralclean. The glue is applied to one side, then the glued surfaces are brought together and clamped firmly until the joint sets (ca. 10 s). Full functional strength is reached after approx. 5-10 min. Minimum application temperature: 5°C

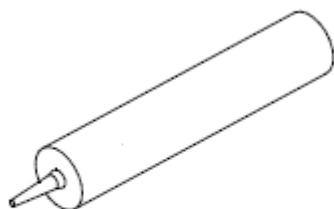

14614959

Fire resistant foam

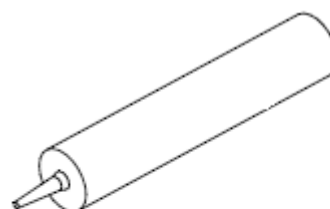

14614967

Fire resistant silicone



CERTIFICATE No CF 5784

Oxted Window Systems Ltd and OWS Fire Rated Ltd

List of Hardware for Approved Aluminium Doorsets Type MB[®] 78 EI

The doorsets of the MB-78EI system can be equipped with the following hardware elements:

Hinges:

- **Dr.Hahn:** 60AT, Turband 4, Rollenband NG.
- **WALA:** WL, WS, WX.
- **FAPIM:** Loira, Loira +.
- **Savio:** Meccanica.
- **ROTO Gluske-BKV:** BKV 80 ATB, 20978.202, 20978.204, 20978.205, 20978.206.

Locks:

- **ECO Schulte:** GBS 70, GBS 71, GBS 72, GBS 73, GBS 74, GBS 75, GBS 76, GBS 96, GBS 97, GBS 98, 1155.
- **KFV:** KFV AS 20xx FS, KFV AS 23xx FS, KFV AS 24xx FS, KFV AS 25xx FS, KFV AS 26xx FS, KFV 2750 FS; for smoke protection doorsets: KFV AS 20xx RD, KFV AS 23xx RD, KFV AS 24xx RD, KFV AS 25xx RD, KFV AS 26xx RD, KFV AS 26xx RD, KFV 49 AP, KVF 44 AP-PZW 35, KVF 45 AP-PZ 35,
- **BKS:** BKS series 1311, BKS series 1800 (excluding: 1812, 1822, 1823), BKS series 1900 with locking plates series 9000,
- **CISA:** 43520, 43521, 43525, 43530, 43535, 46218, 46219, 46225, (46700, 46725), 48128, 48229, 48726 anti panic: 43225, 43235, 43236, 43220, 43230, 43231, 43232, 43250, 43260, 43261, 43262, 43290, 43620, 43630, 43631' 43632, 43650, 43660, 43661' 43662, 43690, 43091, anti burglar anti panic: 43625, 43635, 43636, 43695, 43725,43735,43825,43835,43295.
- **DORMA:** 180,181,182, anti panic: SVP 2000, SVP 4000, SVP 5000, SVP 6000.
- **WILKA:** 457 Z, 458 Z, 467 Z, 467 F, 468 Z, 477 Z, 478 Z, 633 Z, 633 N, 634 N, 638 Z, 4685, 4686, 4657, 4658, 4660, 4663, 4667, 4668, 4677, 4678, 462E.
- **ABLOY:** EVO 200, 300, 400, 600, 700. o ASSA: EL 460, EL 461, EL 420.
- **ISEO:** 741350, 781351 IFZ, series 741, series 781 IFZ.
- **NUOVA FEB:** 7696P/3, 7693PC/3.
- **NEMEF:** 9603/8, 9673/8.
- **CORNI:** 45000535, 45000835.
- **EFF EFF:** series 309, 409,509, 519, 709, 809, 819, MEDIATOR set (lock series 609 + linear electric lock 65XX).

CERTIFICATE No CF 5784

Oxted Window Systems Ltd and OWS Fire Rated Ltd

List of Hardware for Approved Aluminium Doorsets Type MB[®] 78 EI (continued)

Closers:

- **ECO Schulte:** TS 11, TS 11EN, TS 11F, TS 12, TS 20, TS 21, TS 31, TS 40, TS 41, TS 50, TS 51, TS 61, rail S, B, EF, EFR, SR, SREF1 G, SREF1 S, SREF2, SREFR1 G, SREFR1 S, SREFR2,
- **BKS:** OTS 330 FS, OTS 430 FS, OTS 530 FS, OTS 633, OTS 634, OTS 730 FS, OTS 730 FE, OTS 730 FER, OTS 730 SRI, OTS 730 FE SRI, OTS 730 FER SRI, OTS 730 FE BG, OTS 730 FER BG, OTS 730 SRI BG, OTS 730 FE SRI BG, OTS 730 FER SRI BG; with driver BKS series 8400, UTS 85 F, UTS 85 FE, UTS 85 FL
- **CISA:** D0415.03, D1415.03, 71415.03, 71415.05, 71455.05, 71510.03, 71510.05, 71610.03, 71615.03, 72010.03, 72110.03, 72115.03.
- **ABLOY:** DC240, DC 250, DC405, DC403.
- **MAB:** 609DV, 750, 4240.
- **GEZE:** TS 2000V, TS2000V BC, TS 3000V, TS 4000, TS 4000 S, TS 4000 E, TS 4000 R, TS 4000 EFS, TS 4000 RFS, TS 4000 IS, TS 4000 E-18, TS 4000 R-18, TS 4000 force 5-7, TS 5000, TS 5000 L, TS 5000 S, TS 5000 E, TS 5000 R, TSA 160NT, TSA 162, TSA 160NT-IS, TSA 160NT Z, TSA 162 Z, TSA 160NT Z-IS, TSA 160 NT F, TSA 160NT Invers, TSA 160NT Z Invers and derivative, Slimdrive EMD-F, Slimdrive EMD-F-18, Slimdrive EMD Invers.
- **DORMA:** TS 71, TS 72, TS 73V, TS 73 EMF, TS 73 EMR, TS 83, TS 89, TS 90 Impulse, TS 91, TS 92, TS 93, TS 93 EMF, TS 93 EMR, TS 93 GSR, TS 93 GSRI BG, TS 93 GSRIEMF, TS 93 GSR-EMF/BG, TS 93 GSRIEMR, TS 93 GSR/EMR/BG, TS 99 FL, TS 99 FLR, Dorma CD 80, Dorma ED 200, Dorma RMZ, Dorma RM, Dorma RMZ 2, Dorma RM-S, BTS 75V, BTS 80F, BTS 80 BSR.
- **GROOM:** GR 150, GR 200.

Locking coordinating devices:

- **CISA:** 07084.10, 07084.11, 07084.20, 07084.21.
- **DORMA:** MK,SR,GSR. o **ABLOY:** FD 440, FD 460, FD 461, FD 462, FD 464.
- **FAPIM:** 8535.
- **BKS:** OTS 730 SRI, B 8641.
- **GEZE:** rail ISM, rail ISM-BG, rail E-ISM, rail E-ISM-BG, rail R-ISM, cable mechanism RKZ for TS 4000, bar locking coordinating device SR.

Latches and push bars:

- **EGO Schulte:** EPN 900, EPN 2000-pushbar. o **FAPIM:** PANAMA (8015, 8015X, 8035, 8035X, 8039, 8022, 8022X, 8435, 8435X, 8539, 8040, 8040X with accessories 8415, 8415X, 8435, 8435X, 8100, 8105, 8450, 8452, 8480, 8504F, 8510, 8530, 8540, 8140, 8140X, 8145, 8145X, 8529F, 8565),
- **ISEO:** Idea 940, Idea 941, Idea-Push, Push-bar 9449, Idea base IS-941-4000*, Idea PushiS-942-4*, Idea base inox.





CERTIFICATE No CF 5784

Oxted Window Systems Ltd and OWS Fire Rated Ltd

List of Hardware for Approved Aluminium Doorsets Type MB[®] 78 EI (continued)

Latches and push bars:

- **CISA:** 59605.00, 59606.00, 59615.12, 59616.00, 59616.12, 59710.00, 59710.01, 59710.10.FR, 59710.11.FR, 59000.10.FR, 59010.10.FR, 59015.10.FR, 59050.10.FR, 59060.10.FR, 59065.1 O.FR, 59800.1 O.FR, 59800.11.FR, 5981 0.09.FR, 59810.10.FR, 59810.11.FR, 59815.10.FR, 59815.11.FR,
- **DORMA:** PHA 2000 (with steel elements 35014 2102 xxxx and accessories 35014 3905 xxxx, 35014 2203 xxxx, 35014 2204 xxxx, 35014 2205 XXXX, 35014 2104 XXXX, 35014 2105 XXXX, 35014 2520 0050, 35014 2520 0051, 35014 3920 0050, 35014 3920 0060, PHA 2500 (3502511 01 xx -T 350251118xx), PHB 3000 (with steel elements 35014 31 04 xxxx, 35014 31 05 xxxx and accessories 350 14 3202 XXXX, 35014 3905 XXXX, 35014 2204 XXXX, 35014 2205 XXXX, 35014 3203 xxxx, 35014 3204 xxxx, 35014 3905 xxxx, 35014 3920 0050, 35014 3920 0061), Exit Pad F (with steel elements 35014 2112 xxxx, 35014 2211 xxxx), HZ (latches).
- **NEMEF:** Nemef 3640.
- **SAVIO:** BERNINI (6001.1/1200, 6001.2/1200, 6001.3/1200).
- **BKS:** BKS series 7192 i 7100, series 7130 i 7131, series 7150.
- **WILKA:** 4900, 4901.
- **NUOWA FEB:** Series ARTIGLIO, Series COMPOSIT, Series MILLENIUM PUSH.
- **ASSA:** 1130, 1130:1.
- **CORNI:** 44900 92, 42600 92.
- **JPM:** 990001,991001, TA1121, TA2121, TB1121, TB2121.

Electric locks:

- **EFF EFF:** series 131, 141, 142, 143, 118F, smoke control doorsets-series 111, evacuation fire doorsets series 331 , 332 working with additional lock series 807.
- **CISA:** 15100,15101,15102,15110,15120,15121,15122,15130.
- **DORMA:** Dorma 442, Dorma 442RR, Dorma 447, Dorma 447RR, Dorma 117RS for smoke control doorsets, Dorma 117RR RS for smoke control doorsets ,
- **BKS:** B 9242, B 9243.
- **WILKA:** ET10, ET20.
- **GEZE:** reverse anti panic type 331, 332.

Electromagnetic locks:

- **EFF EFF:** series 837, 838, 839, 858.
- **DORMA:** series EM, EMF. o GU BKS: series B 8400.
- **GEZE:** sliding rail TS 5000E, gripper GEZE, armatures MGL.



CERTIFICATE No CF 5784

Oxted Window Systems Ltd and OWS Fire Rated Ltd

List of Hardware for Approved Aluminium Doorsets Type MB[®] 78 EI (continued)

Door handles with electric locks:

- CISA: 07074.70, 07074.71, 07074.80.

Hardware elements:

Hardware elements for single and double leaf doorsets of MB -78EI system shall be in conformity with the following product standards [2.3]:

- BS-EN 1935:2003+AC:2005 -hinges,
- BS-EN 12209:2005+AC:2006-locks,
- BS-EN 1906:2003-lever handles and knob furniture,
- BS-EN 1154: 1999+A 1 :2004 -closers,
- BS-EN 179: 2009 -emergency exit devices,
- BS-EN 1125: 2009-panic exit devices,
- BS-EN 1303:2007+AC:2008-cylinders for locks.

Hardware elements for the use in single and double leaf doorsets of MB -78EI systems shall be introduced to the trade with CE marking.

Other hardware elements of the same type can be used if their fire resistance characteristic was confirmed on the test element of specified construction (according to definition in PN-EN 14600:2009):

- In small scale fire resistance tests in accordance with PN-EN 1634-2:2009 or
- In full scale fire resistance tests in accordance with PN-EN 1634-1:2009.

Types of hardware elements shall be adjusted to weight of the door leaves and service loads. Using alternative hardware equipment must not result in changes being made to the doorset construction.

